

LSN-400 series



PEGASUS®

Serging unit suitable for small parts and long panels

One unit playing two roles!

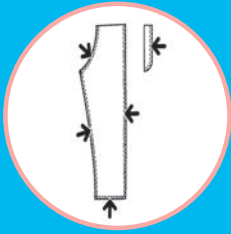
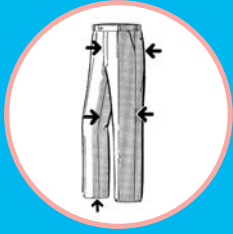

Small parts



Long panels



This serging unit serges small parts to long panels reliably, with outstanding ease of operation!

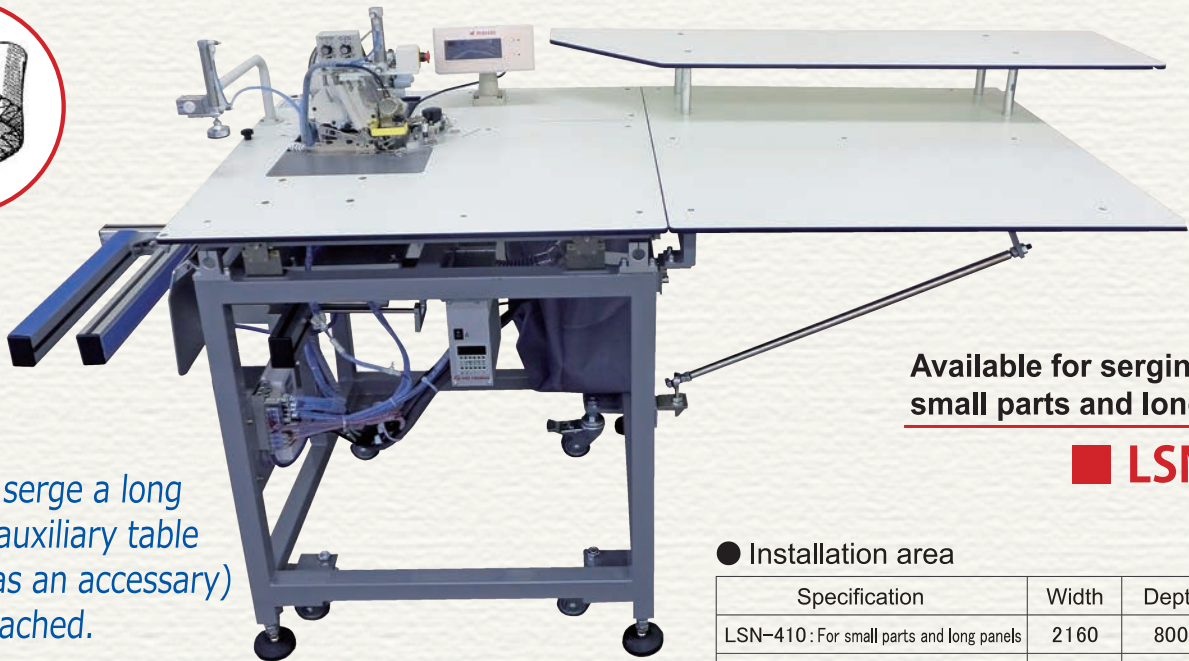

When you serge a long panel, an auxiliary table (included as an accessory) can be attached.

Available for serging small parts and long panels

LSN-410

● Installation area

Unit: mm

Specification	Width	Depth	Height
LSN-410: For small parts and long panels	2160	800	900
LSN-420: For small parts	800	800	900
LSN-430: For long panels	2160	800	900

■ Line up



Exclusive for serging small parts

LSN-420



Exclusive for serging long panels

LSN-430

Available for serging small parts and long panels!

This machine can serge long panels, such as pants and skirts as well as small parts, such as the facings of pants and skirts.

When you serge a long panel, an auxiliary table (included as an accessory) can be attached.

The operator simply places the fabric at the position of the sensor. The unit sews the fabric and trims the thread easily.

Small parts

Long panels

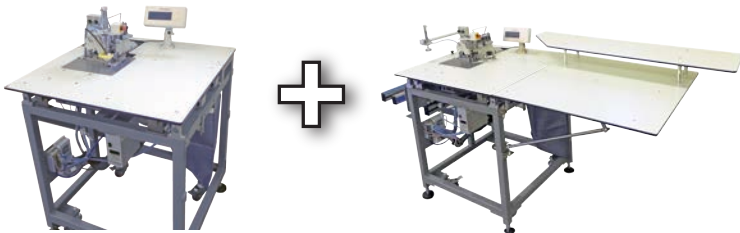

One unit playing two roles!





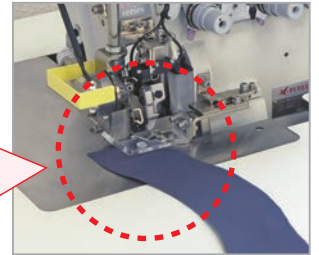
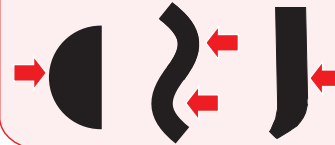

Beautifully-finished stitches are produced even on small parts!

This unit includes the edge controller, gauge parts, fabric guide, etc. specified for turning in small radius. The operator simply places the fabric. Beautifully-finished stitches are produced even on small parts, such as S-shaped parts, half-circle shaped parts or similar parts. Outstanding ease of operation for the operator has been achieved on this series.

Beautifully finished S-shaped and/or semicircle parts can be obtained.



Equipped with: MX5204-22Z5/213-5/KS0A/Y2159

	 No. of needles	 No. of threads	 (mm)	 (mm)	 (mm)	 (sti/min)	
Serging	1	3	5	0.6-3.8	0.7-2.0	5	7,000

Packed with user friendly design

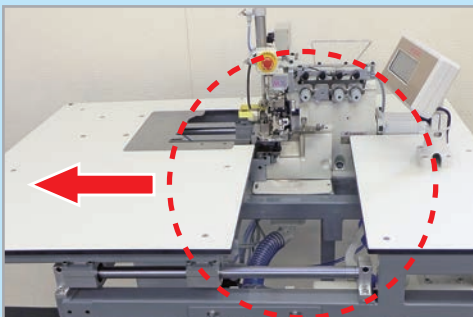

The sewing machine table slides smoothly, so threading the machine, maintenance and cleaning around the machine are easy.



The machine speed and the edge controller pressure can be readily adjusted with the knobs placed at the front of the machine.

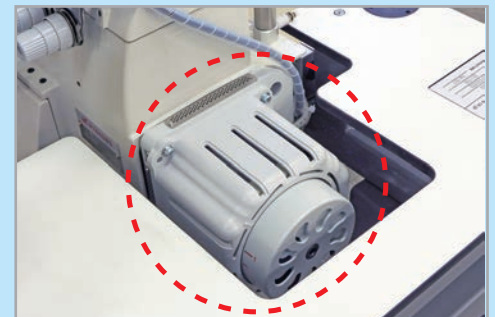

Equipped with a direct drive motor, the machine has a very good response when it starts/stops, and the underside of the machine table is clear.

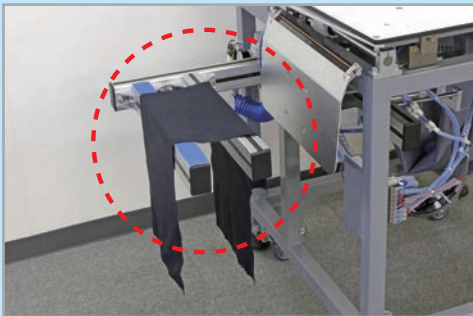

Equipped with a stacker (except the LSN-420 series), stacking the finished fabric is performed neatly and consistently.

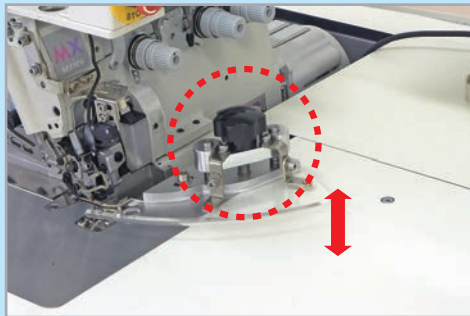

The guide height can be adjusted effortlessly according to the fabric thickness.



Equipped with a touch-screen type controller, a frequently-used function can be called up intuitively and immediately, and easily set.

